

REV	DESCRIPTION	DATE	CHANGED
A			

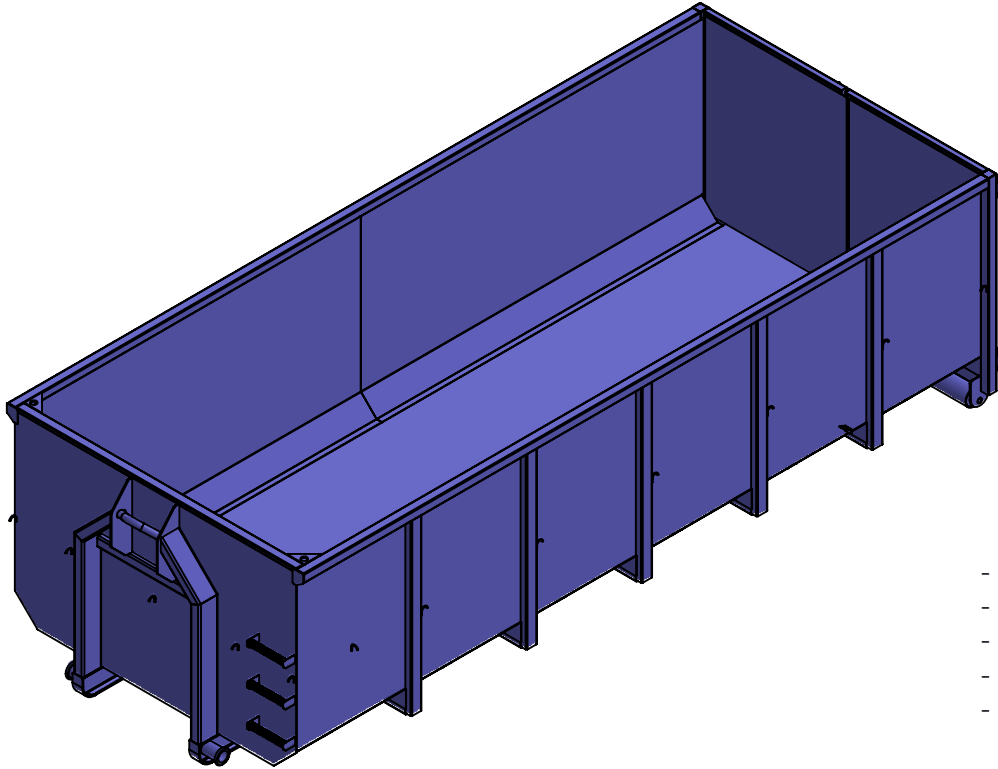
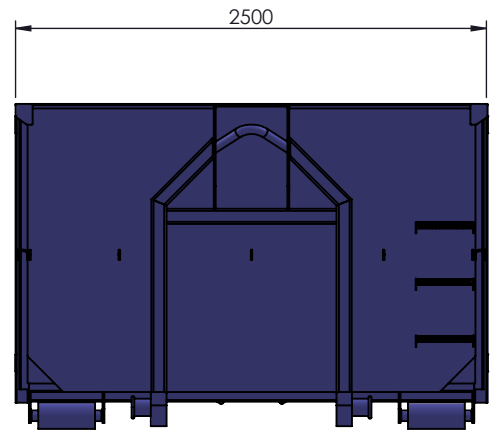
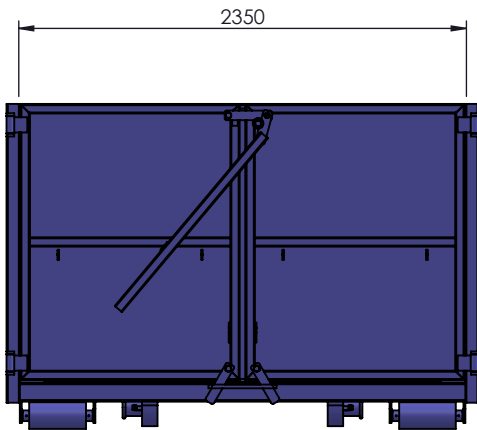
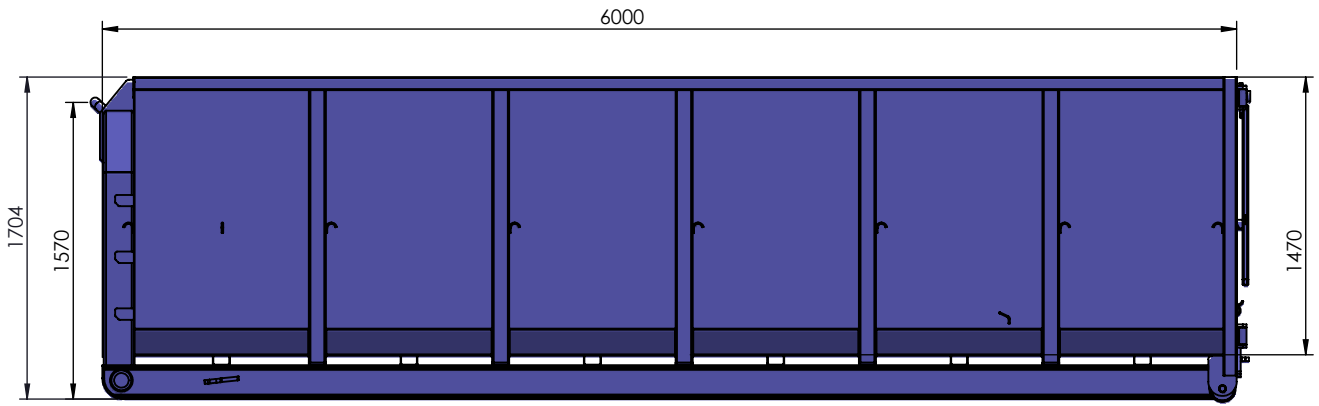

- Laidat S=3
- Pohja S=4
- Pariovet
- Maahanlaskurullat
- Pressukoukut ja portaat

General tolerance, Welding: EN ISO 13920

General tolerance, Machining: ISO 2768-mK

Drawn: 8.9.2016

Name Mittapiirros

SCALE:1:50

SHEET 1 OF 1



Name2 Yleislava 21 m3 (6 x 1,5m)

A4

100-0004

A